



N-300  
OWNER'S MANUAL  
HUMIDIFIER



Welcome to comfortable indoor air with TruSens. Thank you for allowing us to join you on your journey towards wellness.

## CONTENTS

SAFETY INFORMATION	4
FEATURE HIGHLIGHTS	6
PRODUCT OVERVIEW	7
GETTING STARTED	8
CONTROL PANEL	10
SENSORPOD	11
SPECIFICATIONS	12
AROMATHERAPY	13
REPLACING THE WATER FILTER	14
CARE & MAINTENANCE	15
FAQ & TROUBLESHOOTING	17
WARRANTY & SUPPORT	19

## SAFETY INFORMATION

### READ AND SAVE THESE INSTRUCTIONS / READ THE LABEL AND ANY OPERATING MANUAL BEFORE USING

Unplug or disconnect the appliance from the power supply before replacing filters, or when appliance is not in use. Unplug or disconnect the appliance from the power supply before cleaning the base.

### PRECAUTIONS

 **WARNING:** To reduce the risk of fire or electric shock, do not use this appliance with any solid-state speed control device.

Do not operate any humidifier with a damaged cord or plug, or if the wall socket is loose.

Do not run cord under carpeting, throw rugs, runners, or similar coverings. Do not run cord under furniture or appliances. Arrange cord away from traffic area and where it will not be tripped over.

- Never handle the plug with wet hands.
- Do not touch the mist when in warm mist mode.
- Remove all packaging, including the filter bag, before use.
- Unplug the humidifier and empty the water tank before moving. Always carry by the base.
- Always place the appliance on a dry, firm, flat surface that is free from obstructions.
- Appliances that are obviously damaged must not be operated.
- Do not pour water into the mist outlet or chimney.
- Always fill the water tank with clean, cold water. Do not overfill the water tank.
- If you have concerns with your local water quality or if you have especially hard water, use distilled water.
- Always place the water tank directly onto the base when there is water in the tank.
- Do not add essential oils directly to the water tank. Do not use synthetic fragrances.
- Always empty any water from the water tank before cleaning or before replacing the filter.
- Locate humidifier near the outlet wall socket and do not use extension cords.

- This appliance can be used by children aged from 8 years and above and persons with reduced physical, sensory or mental capabilities or lack of experience and knowledge if they have been given supervision or instruction concerning use of the appliance in a safe way and understand the hazards involved.
- KEEP OUT OF THE REACH OF CHILDREN. Children shall not play with the appliance.
- Do not attempt to service or repair this product yourself.
- Only use the humidifier with the power cable provided.
- Only clean this machine with a damp cloth, do not use solvents or bleach.
- Be aware that high humidity levels may encourage the growth of biological organisms in the environment.
- Do not permit the area around the humidifier to become damp or wet. If dampness occurs, turn the output of the humidifier down. If the humidifier output volume cannot be turned down, use the humidifier intermittently. Do not allow absorbent materials, such as carpeting, curtains, drapes, or tablecloths, to become damp.
- Unplug the appliance during filling and cleaning.
- Never leave water in the reservoir when the appliance is not in use.
- Empty and clean the humidifier before storage. Clean the humidifier before next use.
- Empty the tank and refill every third day. Before refilling, clean it with fresh tap water or cleaning agents if required by the manufacturer. Remove any scale, deposits, or film that has formed on the sides of the tank or on interior surfaces, and wipe all surfaces dry.
- Do not place any part of the humidifier in a dishwasher.
- Do not submerge the base reservoir under water at any time.
- Do not block or obstruct the mist outlet or chimney.
- Do not insert fingers or other items into the mist outlet or chimney.
- Do not place foreign objects in the water tank or base reservoir.
- When the humidifier is in standby mode the SensorPod is still transmitting a signal/data.
- Let the appliance cool down before cleaning. Water spilled from the appliance may be hot and a burn hazard.
- Replace any leaking batteries immediately. Remove the batteries if the appliance is being stored for long periods.
- Safely dispose of or recycle used batteries per local regulations.

 **WARNING:** Micro-organisms that may be present in the water or in the environment where the appliance is used or stored, can grow in the water reservoir and be blown in the air causing very serious health risks when the water is not renewed and the tank is not cleaned properly every 3 days.



**WARNING:** The water and heater may cause burns. Unplug the humidifier and let cool before cleaning.



**WARNING:** Skin or eye damage may result from directly viewing the light produced by the lamp in the apparatus.

This appliance contains a UV-C bulb. Avoid exposing the eyes and skin to UVC radiation as it may cause eye and skin injury.

- This appliance contains an UVC emitter.
- Unintended use of the appliance or damage to the housing may result in the exposure of UVC radiation.
- UVC radiation may cause eye and skin irritation.
- Avoid exposing eyes and skin to UVC radiation.

**FIRST AID INSTRUCTIONS** - Seek medical attention in event of injury.

The use of this device is a supplement to and not a substitute for standard infection control practices; users must continue to follow all current infection control practices, including those practices related to cleaning and disinfection of environmental surfaces.

A minimum separation distance of 0.2m must be maintained between the user's body and the device, to comply with RF exposure requirements.

### CONFORMITY INFORMATION

This device complies with radio-communications requirements. This equipment has been tested and found to comply with the radio-communications limits.

These limits are designed to provide reasonable protection against harmful interference in a residential installation. This equipment generates, uses and can radiate radio frequency energy and, if not installed and used in accordance with the instructions, may cause harmful interference to radio communications.

However, there is no guarantee that interference will not occur in a particular installation. If this equipment does cause harmful interference to radio or television reception, which can be determined by turning the equipment off and on, the user is encouraged to try to correct the interference by one or more of the following measures:

- Reorient or relocate the receiving antenna.
- Increase the separation between the equipment and receiver.
- Connect the equipment into an outlet on a circuit different from that to which the receiver is connected.
- Consult the dealer or an experienced radio/TV technician for help.

Changes or modifications not expressly approved by the party responsible for compliance could void the user's authority to operate the equipment.

### End of Life Disposal and Recycling

At the end of its useful life please do not dispose of this electrical/electronic product and any consumables as unsorted waste in general kerbside collections. Please dispose of this product and any consumables using a facility near your home or office that will disassemble and suitably dispose or recycle the components. Recycling of this product is geared toward protecting the environment, protecting human health, preserving raw materials, improving sustainable development, and ensuring a better supply of commodities. Households should contact their local council for the nearest community recycling centres. Businesses should contact their waste disposal services.

# FEATURE HIGHLIGHTS



**SensorPod™**  
Remote humidity monitor with integrated remote-control functionality.



**Informs and Adapts**  
Humidifier displays relative humidity percentage in real-time and reacts to maintain your desired level of humidity in the room.



**Water Softening Filter**  
Softens the water to help prevent the buildup of mineral scale.

**UV-C**

**UV-C Light**



**Warm & Cool Mist**  
Customize your comfort level with either warm or cool mist.



**Top Fill Design**  
Lightweight water tank lid allows easy refilling and cleaning of the large capacity water tank.

# PRODUCT OVERVIEW

## Humidifier

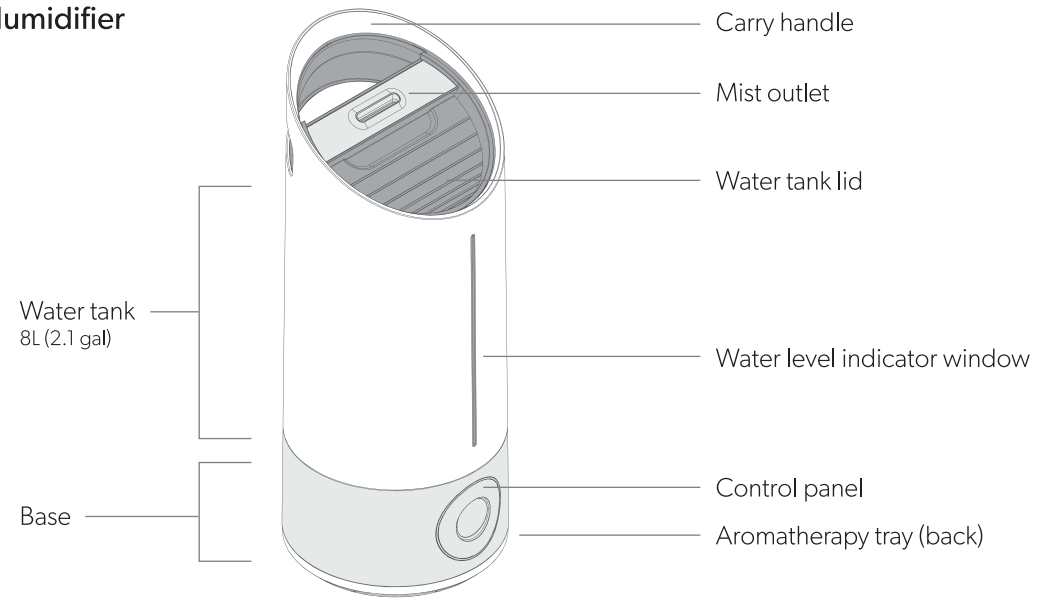

## SensorPod™

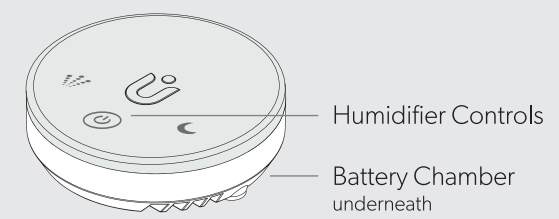

## Filter

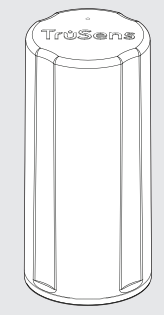

## GETTING STARTED

**! WARNING**  
 Always unplug the humidifier before removing the water tank. Empty all water before cleaning water tank, replacing filter or moving the humidifier. Only place the water tank on a hard, solid surface; do not place on carpeting.

### 1. Prepare the water filter

Remove plastic bag from filter. For optimal performance, submerge filter in bowl of water for 1 hour.

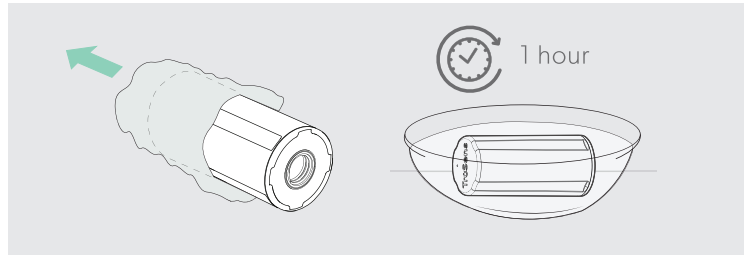

### 2. Install the water filter

a) Unscrew grey cap. b) Secure the filter onto grey cap. c) **Tightly secure grey cap with filter onto water tank until indicator meets lock symbol.** Failure to properly tighten grey filter cap may result in leaking. Return water tank on top of base.

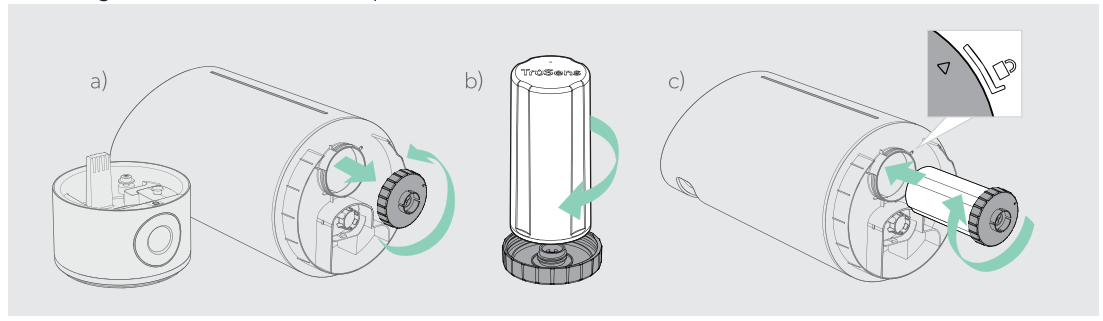

### 3. Fill the water tank

Remove water tank lid and fill with room temperature water (preferably distilled) with jug. The light in the tank is blue when it contains sufficient water (tank is red when it needs refilling).

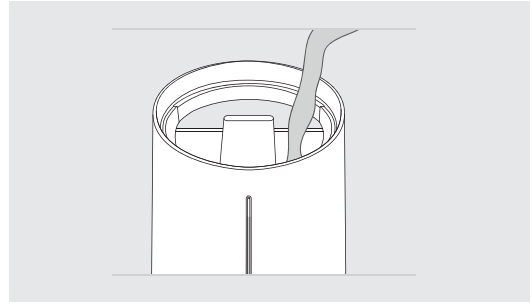

**! WARNING:** Do not pour water into the mist outlet or directly into the base/reservoir. Do not fill over the "Max" indicator line.

**! CAUTION:** Heavy object. To avoid injury always fill tank from the top and use care when lifting.

### 4. Set up

Place humidifier on a dry, firm, flat surface that is free from obstructions.  
**NOTE:** Failure to properly tighten grey filter cap may result in leaking.  
 Open lid of battery chamber found on SensorPod (bottom) and insert 2 AAA batteries (provided). \* SensorPod will automatically begin monitoring if humidifier is on.  
 For optimal results, place SensorPod on a tabletop or counter across the room, within line of sight of the humidifier.  
 Control the humidifier with the touch buttons on SensorPod.

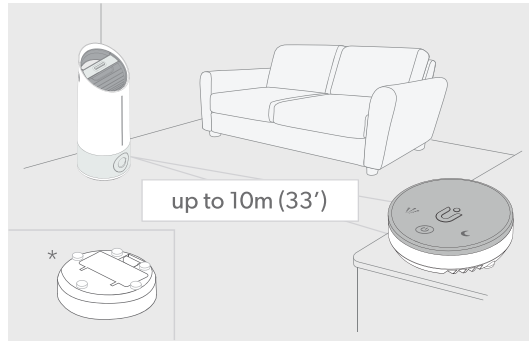

**NOTE:** When the base reservoir is completely dry, like at the first use or at the start of each new season, there may be a delay of up to 30 seconds before mist is produced.

## CONTROL PANEL



### -/+

#### Target Humidity

Press the – or + button to set your own target humidity between 40 - 60%. The humidity level will be displayed as a percentage on panel (i.e. 45 = 45%).



#### Filter Change Indicator

Filter indicator glows red when it is time to be replaced. To reset, simply hold the Filter Reset button for 3 seconds.

If you replace the filter before the indicator turns red, simply hold the Filter Reset Button for 10 seconds to notify the humidifier that a new filter has been installed.

(See page 14 for replacement instructions. Follow above Reset button instructions after replacing filter.)



#### Misting Speed Settings

Select misting speed (1/2/3) or AUTO mode. In AUTO mode, humidifier will only produce mist when SensorPod measures humidity lower than target humidity setting. Default AUTO mode setting is 50% relative humidity.



#### Dimmer Mode

Display illumination turns off – for use while sleeping – without sacrificing the effectiveness of the humidifier. Simply press the button again to bring back all display features.



#### Power Button



#### Warm Mist

When on, mist is warmed.

Note: It will take a few minutes to achieve its full temperature.



#### Timer Mode

Humidifier will automatically turn off after 2, 4, 8, or 12 hours. To cancel this countdown, simply press button until no timer setting is displayed.

## SENSORPOD™

#### Remote Control

The SensorPod reads the humidity level where it is placed. The battery operated SensorPod should be positioned in line-of-sight of the humidifier; up to 10m (33') away.

The SensorPod is also a remote control for your humidifier. Power on and off, adjust the misting speed, and dim the lights on the display.

The SensorPod communicates with the humidifier using radio frequency signals and will be pre-paired on the production line and ready for use when you open the box.

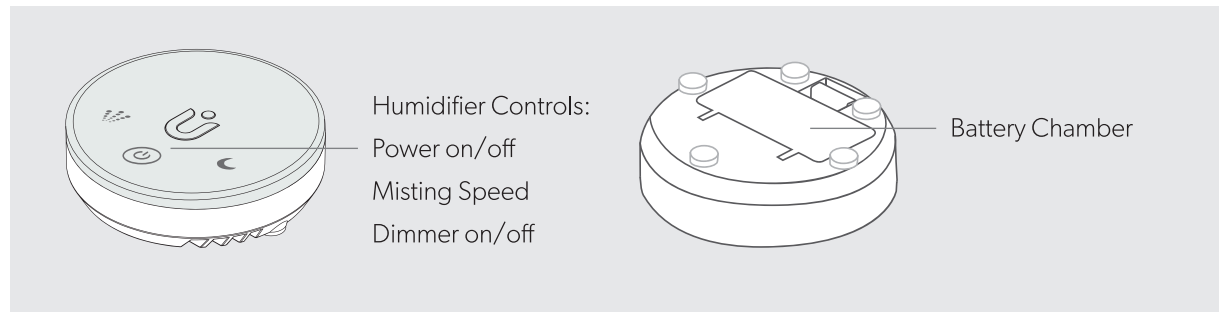

Humidifier Controls:

- Power on/off
- Misting Speed
- Dimmer on/off

Battery Chamber

## SPECIFICATIONS

Model	N-300
Tank Capacity	8 Litres (2.1 gallons)
Max Mist Output	300 ml/h (cool)
Operating Time	26 - 80 hours
Room Size	Up to 45 m sq. / 485 sq. ft
Sensor	SensorPod™, works up to 10m (33 ft) from humidifier
Misting Speed Settings	1, 2, 3, Auto
Timer Settings	2, 4, 8, 12 hr
Warm Mist	40° C (104° F) at atomizer
Empty Tank Indicator	Water tank LED turns red
Filter Change Indicator	Yes
Noise Level	41.0 dB Max
Dimensions	Ø 224 x 578mm (Ø 8.8" x 22.8")
Weight (empty)	3.3kg (7.3 lbs) with filter
Power Requirements	100-240V 50/60Hz 1.0A
Power Consumption	16 - 67.2W / 128 - 182.4W (Warm)
Warranty	3 years

### Replacement Filter & Pads

Water Softening Filter	WSF300-01	1 pack	Replace after 4 months (with normal use)
Aromatherapy Pads	ATP300-01	10 pack	Replace as needed

## AROMATHERAPY

The humidifier includes an aromatherapy drawer, at the back of the unit, that allows you to add your favorite essential oils for an enhanced experience.



### WARNING

Do not use any synthetic fragrances - only use 100% natural essential oils. Do not add essential oils directly into the water tank.

### Adding Essential Oils

Open the aroma drawer on the back of the humidifier & apply 2-3 drops of essential oil to the aroma pad (Fig. A).

When you are ready to replace the aroma pad, gently remove the pad from the aroma drawer, and replace with a new pad making sure to secure the pad using the tabs (Fig. B).

Refer to page 12 for aromatherapy pad replacement part number.

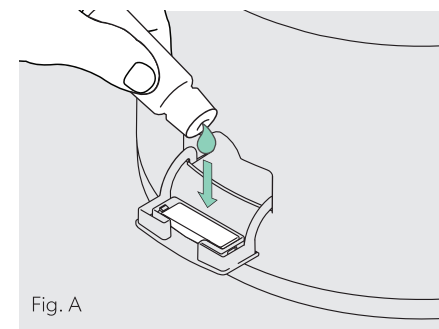

Fig. A

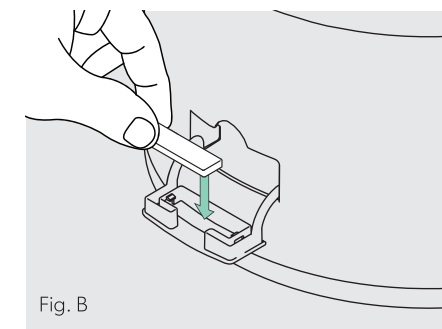

Fig. B

## REPLACING THE WATER FILTER

The filter indicator will glow red when it is time to change the ion exchange filter.

Note: The filter should also be replaced after the humidifier has been stored away for a season or more.

**WARNING:** Always unplug the humidifier before removing the water tank. Always empty any water from the tank before replacing the filter.

Note: Remember to submerge the replacement water filter in a bowl of water for 1 hour before using (Fig. C).

### Accessing the filter

1. Remove the water tank from its base, pour out any water into a sink and gently place on its side so that the grey filter cap is exposed and accessible.
2. Turn the grey cap counter-clockwise to remove the filter from the water tank (Fig. D).
3. Remove current filter from grey cap in a counter-clockwise motion (Fig. E). Secure replacement filter onto grey cap threading in a clockwise motion (Fig. F).
4. Tightly secure grey cap with filter onto the threading on the bottom of the water tank and turn clockwise until indicator meets lock symbol (Fig. G).
5. Return water tank on top of base, plug-in and power on your humidifier. Hold the Filter Reset Button until the red indicator turns off.

Refer to page 12 for water softening filter replacement part number.

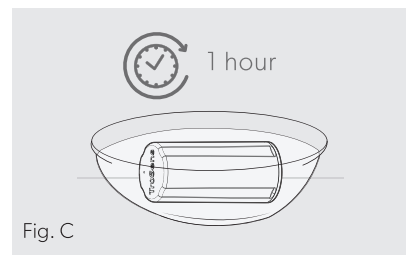

Fig. C

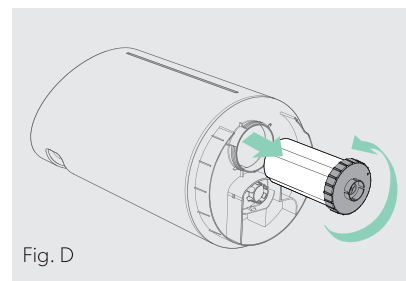

Fig. D

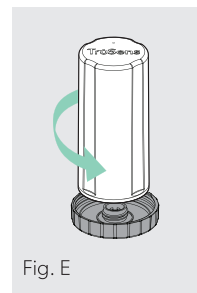

Fig. E

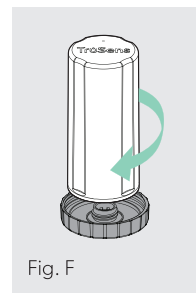

Fig. F

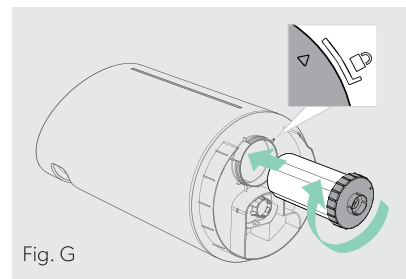

Fig. G

## CARE & MAINTENANCE

Cleaning the tank and base reservoir on a regular basis is critical to ensure the optimal performance of the humidifier. The water filter will help to prevent mineral scale buildup, but a regular cleaning routine is important for addressing mineral scale in areas with especially hard water, as well as to prevent any odors that may be caused by standing water if the humidifier is not used for days at a time.

If you have concerns about your local water quality or if you have especially hard water, we recommend using distilled water.



**WARNING:** Always unplug the humidifier before removing the water tank. Always empty any water from the tank before cleaning. Always allow any remaining water in reservoir to cool before cleaning.

## REGULAR MAINTENANCE

We recommend that the following is carried out when you refill the water tank:

1. Rinse the water tank with water and wipe clean.
2. Dry with clean cloth.

Note: Lower humidity control settings or turn off the humidifier if moisture forms on wall or windows



**WARNING:** Do not use any detergents or cleaning chemicals. Do not place any part of the humidifier in a dishwasher. Do not submerge the base reservoir under water at any time.



## WEEKLY MAINTENANCE

### Base Reservoir

1. Empty the water by pouring out the left side of the base, to avoid splashing onto control panel or power cord inlet.
2. Remove the covers of the UV-C chamber and PTC heater.
3. Pour 600ml of distilled white vinegar into the reservoir, making sure that the atomiser, UV-C chamber and PTC heater are submerged in vinegar. Allow the vinegar to soak for 30 minutes, and then carefully empty the vinegar by pouring out of the left side of the base.
4. Dampen a soft cloth with undiluted white vinegar and gently wipe the reservoir, including all components.
5. Rinse thoroughly with clean water and dry with a clean cloth.

### Water Tank

1. Empty all water out of the tank.
2. Remove filter from tank, and tightly secure the grey cap onto the tank.
3. Add 2 cups of distilled white vinegar and 2 cups of water to the tank.
4. Gently shake the water tank to coat the inner sides of the tank.
5. Allow the vinegar and water to soak inside the tank for 30 minutes.
6. Dampen a soft cloth with undiluted white vinegar and wipe thoroughly around the tank and the outside of the filter.
7. Rinse with clean warm water to remove the mineral scale and vinegar.
8. Dry with clean cloth.

## MAINTENANCE BEFORE STORING

Follow weekly maintenance instructions above. Let the humidifier dry completely before storing. Do not store with water inside the tank or base reservoir. Store in a cool dry place. Clean the humidifier before the next season begins.

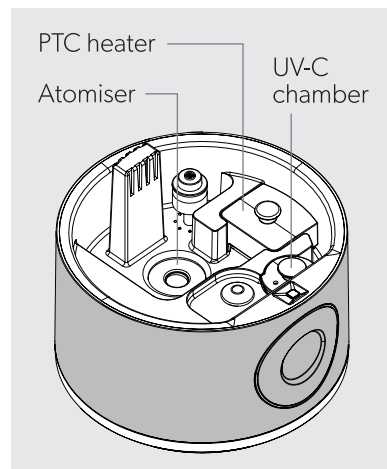

## FAQ & TROUBLESHOOTING

<p><b>Where do I place the SensorPod™?</b></p>	<p>Anywhere you want to measure the humidity within the room. For optimal results, place the SensorPod™ up to 10m (33ft) away from the humidifier on a counter or table, within line of sight of the humidifier. In Auto Mode, the humidifier will work to distribute humidity until the SensorPod reads an acceptable level.</p>
<p><b>How often do I need to change the filter?</b></p>	<p>That's easy! The humidifier's replacement indicator will notify you when it is time to replace the water softening filter. Plan on replacing the water filter every 3-4 months, with normal use of 8 hours per day and average hardness of water.</p>
<p><b>How often do I need to replace the aromatherapy pad?</b></p>	<p>The humidifier comes with one aroma pad. Replace as needed.</p>
<p><b>Humidifier won't turn on.</b></p>	<p>Check that the power cord is connected securely to both the wall outlet and the humidifier. Check if there is a power outage in the outlet by trying a nearby light or device, or by trying a working device in the same outlet.</p> <p>Check that there is water in the tank, and consider filling the tank to the "Max" indicator line.</p> <p>Please contact us if you're still having a problem (page 19).</p>

## FAQ & TROUBLESHOOTING

<p>Humidifier won't go into Auto Mode.</p> <p>OR</p> <p>Humidity indicators are off.</p> <p>OR</p> <p>Humidifier's sensor signal indicator is blinking.</p>	<p>First, check that the SensorPod is within range of the humidifier (up to 10m/33ft)</p> <p>Next, check the SensorPod batteries and consider replacing with new batteries.</p> <p>If the connection is still failing, see below instructions on repairing the SensorPod's connection.</p>
<p>I've lost my SensorPod™!</p>	<p>Don't worry! Please contact our customer support team and you can order a replacement SensorPod. Follow the easy pairing instructions below to pair your replacement SensorPod with your existing humidifier!</p>

### Pairing SensorPod™ and Humidifier

The SensorPod communicates with the humidifier using radio frequency signals, and is already paired and ready for use when you open the box. In the rare event that the signal is interrupted, the humidifier's sensor indicator light  will blink. You can repair the connection in just a few easy steps.

1. HOLD the Power Button on the humidifier for 3 seconds, until you should hear two chimes.
2. HOLD the Power Button on the SensorPod remote control panel for 5-7 seconds.
3. The connection is established when the humidifier's sensor indicator light is lit with no blinking, and the humidity display turns on.

### Warranty Against Defects

This product is provided with a **3 year** warranty limited to defects in material and workmanship from the date of original purchase (you must retain proof of purchase) (**Warranty Period**). This warranty is offered by ACCO Brands Australia Pty Ltd (ABN 16 000 265 047) if the product was purchased in Australia or ACCO Brands New Zealand Limited (26589) if the product was purchased in New Zealand (each referred to individually, as **ACCO Brands**). ACCO Brands will, at its own discretion, either repair or replace this product (with a new or refurbished product) if the defect is deemed by ACCO Brands to be the result of faulty materials or workmanship but subject to the conditions set out in this warranty.

Any other representation contained on this product's packaging or provided with this product which constitutes or appears to constitute a warranty is hereby excluded and is not given by ACCO Brands (except for the statutory warranties as indicated below).

You may claim on this warranty only within the Warranty Period in the manner set out below and provided that you have complied with all the other conditions of this warranty. This warranty can only be exercised by the original purchaser of the product and is not transferrable to any other person or entity under any circumstances.

### Statutory Guarantees and Your Other Rights and Remedies

This warranty is provided in addition to other rights or remedies that you, as a consumer, may have under Australian or New Zealand consumer law, or any other applicable law.

**For Australia:** Our goods come with guarantees that cannot be excluded under the Australian Consumer Law. You are entitled to a replacement or refund for a major failure and compensation for any other reasonably foreseeable loss or damage. You are also entitled to have the goods repaired or replaced if the goods fail to be of acceptable quality and the failure does not amount to a major failure.

**For New Zealand:** Our goods come with guarantees that cannot be excluded under the Consumer Guarantees Act 1993. This guarantee applies in addition to the conditions and guarantees implied by that legislation.

### What this Warranty Does Not Cover

If ACCO Brands reasonably considers that any of the following situations are present, this warranty does not apply:

- any cosmetic damage;
- where the product's serial number is no longer present or visible;
- loss or damage caused by factors beyond the control of ACCO Brands including, but not limited to, damage or failure due to power fluctuations, overload, excessive heat or humidity;
- where the product has not been installed, operated, used, stored and/or maintained in accordance with any instructions provided with the product;
- where damage or defects are due to unusual, abnormal, non-recommended or negligent use, handling or maintenance of the product;
- any alterations or repairs to the product not authorised in writing or performed by ACCO Brands;
- liability based on any service or other agreement or arrangement entered with any third party; or
- normal wear and tear including deterioration of any wearable components or consumables in any product, including but not limited to base boards, blades, cutters, cutting disks, cutting sticks, drill bits, feed wheels, fuses, light bulbs, manual punches, separators, slitters and staple inserts.

### How to Make a Claim

To make a claim under this warranty please contact your place of purchase within the Warranty Period (from the date of purchase). Proof of your purchase of this product, such as your receipt or invoice, must be provided in addition to a detailed description of the defect in the product. Your claim will be assessed under the terms and conditions of this warranty and the laws applicable to your place of purchase.

### Distributor Contact Details

#### Australian Customers

ACCO Brands Australia Pty Ltd  
 Locked Bag 50, Blacktown BC, NSW 2148  
 Phone: 1300 278 546  
 Email: enquiry.nsw@acco.com

#### New Zealand Customers

ACCO Brands New Zealand Limited  
 PO Box 11-677, Ellerslie, Auckland 1542  
 Phone: 0800 800 526  
 Email: enquiry.nz@acco.com

# TruSens™

[www.trusens.com](http://www.trusens.com)

Subscribe to our YouTube channel [TruSens](#)

& Follow us [@trusensanz](#)



ACCO Brands Australia  
2 Coronation Ave  
Kings Park, NSW, 2148  
1300 278 546

©2022 ACCO Brands. All rights reserved. TruSens™, U™ & Design, SensorPod™ and PureDirect™ are trademarks of ACCO Brands.